

ADATTATORI PER FIBRE OTTICHE MULTIMODE - Confezione minima 10 pz.

Corpo in metallo e ferrule in ceramica



Da ST a ST, a vite
Ref. 2-023-100



Da ST a ST, in metallo, con flangia
Ref. 2-023-102

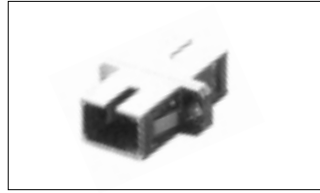

Da SC a SC, in metallo, con flangia
Ref. 2-023-104



Da ST a SC, in metallo, con flangia rettangolare
Ref. 2-023-110

CONNETTORI E ADATTATORI AUDIO PER FIBRE OTTICHE - Confezione minima 10 pz.



Spina 3.5 mm - con custodia in plastica nera
Ref. 2-023-250
Spina 3.5 mm - con custodia in metallo
Ref. 2-023-252



Adattatore da spina toslink a presa jack 3.5 mm
in plastica nera
Ref. 2-023-256



Adattatore toslink femmina-femmina
in plastica nera
Ref. 2-023-260



Adattatore da minipresa 3.5 mm a
minispina 2.5 mm
Ref. 2-023-264



Spina 3.5 mm - con custodia in metallo - 90°
Ref. 2-023-254



Adattatore da spina toslink a presa toslink - 90°
in plastica nera
Ref. 2-023-258



Adattatore doppia mini-presa jack 3,5 mm
Ref. 2-023-262

CAVETTI IN FIBRA OTTICA PLASTIFICATA

Applicazioni: DVD, audio amp, TC, speaker, game, hub, digital VCR, CATV computer



Cavetto diametro 5 mm
Doppia spina toslink lunghezza 1 m
Custodia connettori in metallo
Punta contatti dorata.
Colore giallo oro
Ref. 3-072-421



Cavetto diametro 5 mm
Spina toslink e spina 3,5 mm
Lunghezza 1 m
Custodia connettori in plastica nera
Punta contatti dorata.
Ref. 3-072-427



Cavetto diametro 5 mm con spina toslink a
spina 3,5 mm - lunghezza 1 m
Custodia connettori in metallo
Punta contatti dorata.
Colore marrone chiaro
Ref. 3-072-422

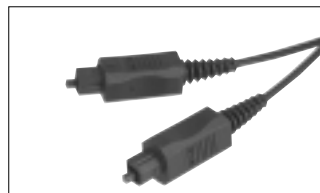

Cavetto diametro 2,2 mm
Doppia spina toslink 3,5 mm
Lunghezza 1 m
Custodia connettori in plastica nera.
Ref. 3-072-429

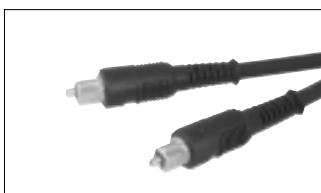

Cavetto diametro 5 mm
Doppia spina toslink -
lunghezza 1 m
Custodia connettori in plastica nera
Punta contatti dorata.
Ref. 3-072-426

ADATTATORI E ACCESSORI PER COMPUTER



Adattatori a 15 poli per RS-232
 da maschio a maschio Ref. 3-072-279
 da femmina a femmina Ref. 3-072-278
 da maschio a femmina Ref. 3-072-274



Adattatori per RS-232 - 25 poli
 Protettore alla sorgente
 da maschio a femmina Ref. 3-072-290



Adattatori a 25 poli per RS-232
 da maschio a maschio Ref. 3-072-280
 da maschio a femmina Ref. 3-072-282
 da femmina a femmina Ref. 3-072-285



Adattatore test per RS-232 - 25 poli
 da maschio a femmina Ref. 3-072-306



Adattatori da 9 poli a 25 poli per RS-232
 da maschio 9 poli a femmina 25 poli Ref. 3-072-288
 da femmina 9 poli a femmina 25 poli Ref. 3-072-289
 da femmina 9 poli a maschio 25 poli Ref. 3-072-287
 da maschio 9 poli a maschio 25 poli Ref. 3-072-286



Adattatore loopback tester - 25 poli
 da maschio a femmina Ref. 3-072-291



RS-232 Null Modem 25 poli
 maschio - femmina Ref. 3-072-303



RS-232 Break out box - Check tester
 25 poli - da maschio a femmina
 Permette di individuare i possibili guasti consentendo anche tramite ponticelli o vari Dip-Switch il circuito voluto Ref. 3-072-293



Adattatori
 da HD 15 poli maschio a 25 poli D maschio Ref. 3-072-266
 da HD 15 poli maschio a 25 poli D femmina Ref. 3-072-267
 da HD 15 poli femmina a 25 poli D femmina Ref. 3-072-268
 da HD 15 poli femmina a 25 poli maschio Ref. 3-072-269



Mini adattatori 9 poli
 da maschio a maschio Ref. 3-072-330
 da maschio a femmina Ref. 3-072-332
 da femmina a femmina Ref. 3-072-334
 Confezione minima 10 pz.



Adattatori Centronic da 25 poli a 36 poli per RS-232 per stampanti IBM compatibili
 da 25 poli maschio a 36 poli maschio Ref. 3-072-298
 da 25 poli maschio a 36 poli femmina Ref. 3-072-299
 da 25 poli femmina a 36 poli femmina Ref. 3-072-301
 da 25 poli femmina a 36 poli maschio Ref. 3-072-297



Mini adattatori 15 poli
 da maschio a maschio Ref. 3-072-331
 da maschio a femmina Ref. 3-072-339
 da femmina a femmina Ref. 3-072-335
 Confezione minima 10 pz.

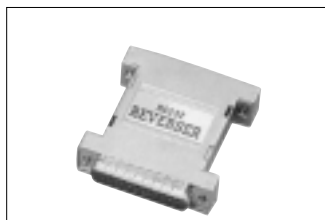

Adattatore Reverser 25 poli
 da maschio a femmina Ref. 3-072-294



Mini adattatori 25 poli
 da maschio a maschio Ref. 3-072-336
 da maschio a femmina Ref. 3-072-338
 da femmina a femmina Ref. 3-072-340
 Confezione minima 10 pz.

ADATTATORI E ACCESSORI PER COMPUTER

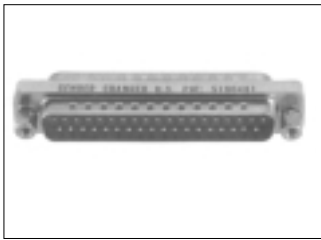

Mini-adattatori a 37 poli
da maschio a maschio Ref. 3-072-342
da maschio a femmina Ref. 3-072-343
da femmina a femmina Ref. 3-072-344
Confezione minima 10 pz.

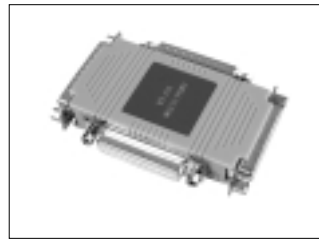

RS-232 multiport gender charger
2 x 25 maschio D e 2 x 25 femmina D Ref. 3-072-389
1 x 25 maschio D e 3 femmine D Ref. 3-072-390
3 x 25 maschio D e 1 x 25 femmina D Ref. 3-072-391
4 x 25 maschio D Ref. 3-072-392
4 x 25 femmina D Ref. 3-072-393



Mini adattatori 15 poli alta densità
HD 15 - da maschio a maschio Ref. 3-072-351
HD 15 - da maschio a femmina Ref. 3-072-355
HD 15 - da femmina a femmina Ref. 3-072-353
Confezione minima 10 pz.

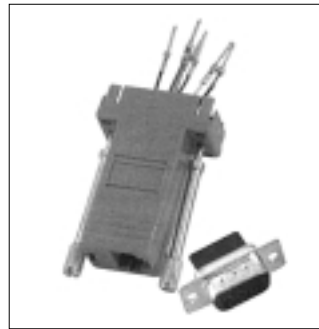

Adattatori da RS-232 a presa modulare
Permettono di collegare un PC IBM compatibile ad una stampante mediante linea telefonica.
Entrata 9 poli D
maschio 4 uscita contatti Ref. 3-072-216
femmina 4 Ref. 3-072-217
maschio 6 Ref. 3-072-218
femmina 6 Ref. 3-072-219
maschio 8 Ref. 3-072-220
femmina 8

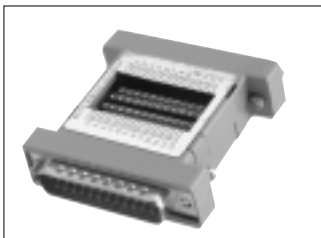

Adattatore RS-232 - 25 poli
Costruito per avere, tramite diversi ponticelli, una configurazione Custom.
Fornito completo di ponticelli.
Da maschio a femmina Ref. 3-072-295



Adattatori da RS-232 a presa modulare
Permettono di collegare un PC IBM compatibile ad una stampante mediante linea telefonica.
Entrata 25 poli D
maschio 4 uscita contatti Ref. 3-072-223
femmina 4 uscita contatti Ref. 3-072-224
maschio 6 uscita contatti Ref. 3-072-225
femmina 6 uscita contatti Ref. 3-072-226
maschio 8 uscita contatti Ref. 3-072-227
femmina 8 uscita contatti Ref. 3-072-228

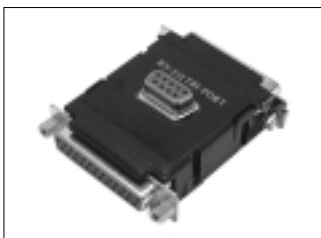

Adattatori seriali a tre uscite
da 25 poli maschio-femmina Ref. 3-072-337
e 9 poli maschio Ref. 3-072-341
da 25 poli maschio-femmina Ref. 3-072-341
e 9 poli femmina Ref. 3-072-341

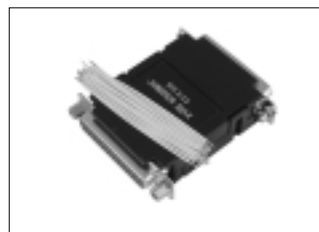

Jumper box a 25 poli - RS-232
Da maschio a femmina
Si possono configurare vari tipi di connessione per poter ottenere il circuito desiderato.
Viene fornito completo di ponticelli e accessori vari Ref. 3-072-295



Mini-tester RS-232
25 poli tutti collegati da maschio a femmina
I Led indicano i 7 segnali a vari colori Ref. 3-072-292

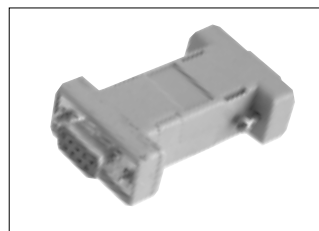

Adattatori a 9 poli per RS-232
da maschio a maschio Ref. 3-072-277
da maschio a femmina Ref. 3-072-275
da femmina a femmina Ref. 3-072-276

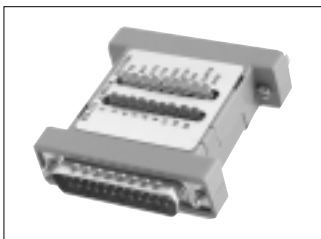

Check-tester RS-232 25 poli
da maschio a femmina Ref. 3-072-284



Adattatori mouse
da 6 poli mini-din maschio a 9 poli D maschio Ref. 3-072-260
da 6 poli mini-din femmina a 9 poli D femmina Ref. 3-072-261
da 6 poli mini-din maschio a 9 poli D femmina Ref. 3-072-262
da 6 poli mini-din maschio a 25 poli D maschio Ref. 3-072-263
da 6 poli mini-din femmina a 25 poli D femmina Ref. 3-072-264
da 8 poli mini-din femmina a 9 poli D maschio Ref. 3-072-265



Adattatore RS-232 universale multiporta
1 x 9 femmina D / 1 x 15 maschio D Ref. 3-072-394
1 x 25 maschio D / 1 x 25 femmina D Ref. 3-072-394

ADATTATORI E ACCESSORI PER COMPUTER

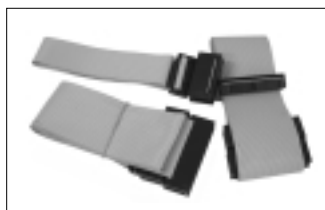

Cavo per drive - 3 pezzi Ref. 3-072-317



Schermi protettivi per monitor a colori (Monitor Filter)
Da apporre sullo schermo del computer per schermare le radiazioni proteggendo la vista; tipo 14" Ref. 3-072-406



Porta CD portatile per 12 CD con maniglia Ref. 3-072-357



Porta CD a colonna per 10 CD Ref. 3-072-370
per 20 CD Ref. 3-072-371

Porta CD a ventaglio per 5 CD Ref. 3-072-368
per 8 CD Ref. 3-072-369

Braccialetto anti-statico
Utilissimi all'operatore di computer quando deve effettuare riparazioni o modifiche su schede che montino integrati C-MOS, memorie e microprocessori che devono essere protetti dalle correnti statiche. Filo lungo ca. 3 mt. Tipo con chiusura velcro Ref. 3-072-372

Kit pulisci-testine
Contiene 2 floppy disk da 5 1/4" e una bottiglietta di soluzione pulente. Ref. 3-072-360
per floppy disk da 3 1/2" Ref. 3-072-362
Fino ad esaurimento scorte

172

PROLUNGHE PER TASTIERE

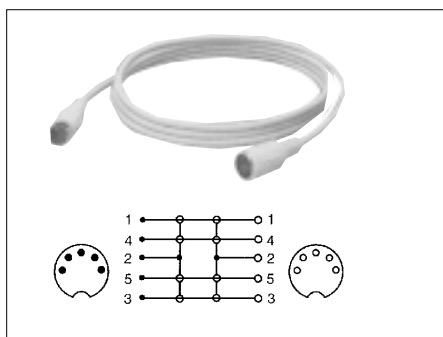

Cavo prolunga per tastiere
Spine-presa 5 poli - Lunghezza 1,80 metri
Ref. 3-072-405

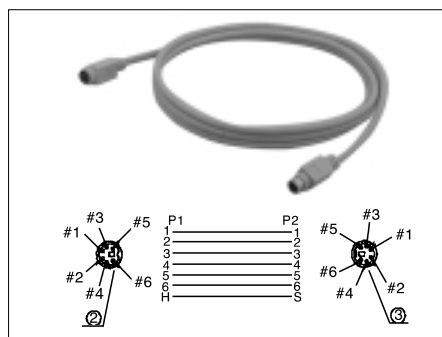

Cavo prolunga per tastiere
Spine-presa mini 6 poli - Lunghezza 1,80 metri
Ref. 3-072-407

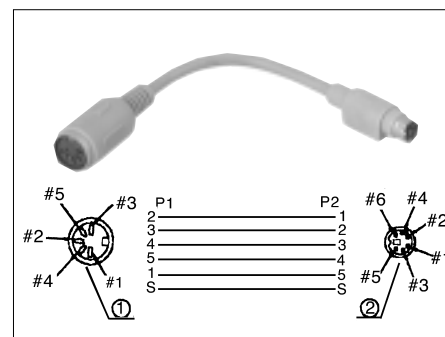

Cavo prolunga per tastiere
Spine-presa da mini 6 poli a presa 5 poli
Lunghezza 1,80 metri Ref. 3-072-408

CAVI DI COLLEGAMENTO PER UNITA' PERIFERICHE PER COMPUTER

Colore grigio - Lunghezza 1 metro

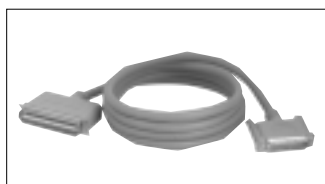

Cavi Centronic per stampante parallela da 36 poli maschio a 36 poli femmina Ref. 3-072-318
36 poli femmina - femmina Ref. 3-072-319

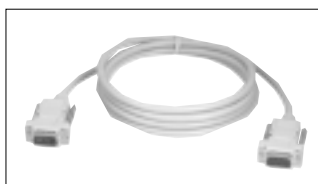

Cavi per monitor IBM compatibili 9 poli D maschio - D maschio Ref. 3-072-322
da 9 poli D maschio a 9 poli femmina Ref. 3-072-324

CAVI DI COLLEGAMENTO PER UNITA' PERIFERICHE PER COMPUTER

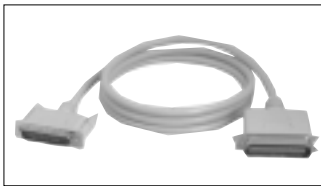

Cavo per stampante parallela IBM compatibile da 25 poli D maschio a 36 poli Centronic maschio Ref. 3-072-316
da 25 poli D femmina a 36 poli Centronic maschio Ref. 3-072-315

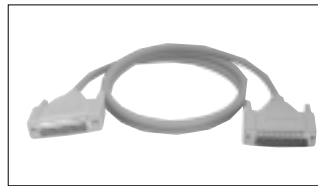

Cavi RS-232 per IBM compatibili da 25 poli D maschio - maschio Ref. 3-072-310
da 25 poli D maschio a 25 poli D femmina per modem 10 conduttori Ref. 3-072-314
da 25 poli D maschio a 25 poli D femmina Ref. 3-072-312
da 25 poli D femmina a 25 poli D femmina Ref. 3-072-328



Cavi RS-449 per IBM compatibili da 37 poli maschio a 37 poli femmina Ref. 3-072-325
37 poli femmina - femmina Ref. 3-072-327



Cavo modem AT-IBM 9 conduttori 25 poli maschio D - 9 poli femmina D Ref. 3-072-326



PS/2 cavo per monitor da 15 poli HD maschio a 9 poli D maschio Ref. 3-072-366
da 15 poli HD maschio a 9 poli femmina D Ref. 3-072-367



Cavo di collegamento RS-232 9 conduttori 9 poli femmina - femmina Ref. 3-072-363
da femmina 25 poli D a femmina 9 poli D Ref. 3-072-364
25 poli D femmina - femmina Ref. 3-072-365



Cavi di prolunga alta densità HD 15 HD 15 poli maschio - maschio Ref. 3-072-410
HD 15 poli maschio - HD 15 poli femmina Ref. 3-072-411
HD 15 poli femmina - femmina Ref. 3-072-412



Autoterminazione a T - cavo 30 cm con due maschi twimaxial e 9 poli femmina Ref. 3-072-415

CAVI SCSI

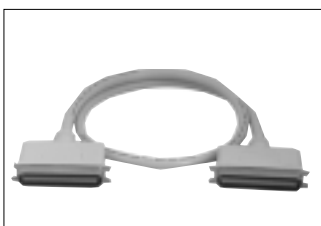

Prolunga cavo SCSI-I 50 poli maschio - maschio centronic Ref. 3-072-305
50 poli maschio - 50 poli femmina centronic Ref. 3-072-307
50 poli femmina - 50 poli femmina centronic Ref. 3-072-309
25 poli D maschio - 50 poli maschio centronic Ref. 3-072-311

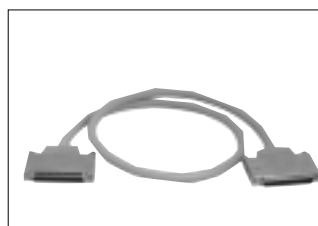

Cavo SCSI -III Maschio-maschio 68 poli HPD68M-HPD68M Ref. 3-072-399



Cavo SCSI-I 25 poli D maschio - 50 poli Centronic maschio Ref. 3-072-313



Cavo SCSI-III a SCSI-II Maschio-maschio 68-50 poli HPD68M-HPD50M Ref. 3-072-400



Cavo SCSI-I a SCSI-II Maschio-maschio 50-50 HPD50M-CEN50M Ref. 3-072-401

CAVI USB E IEE

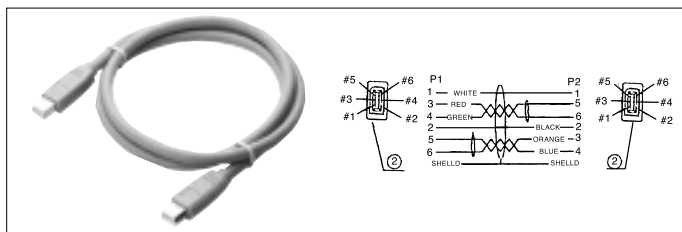

Cavo IEE 1394 da 1,80 m di lunghezza - Colore beige
Ref. 3-072-934

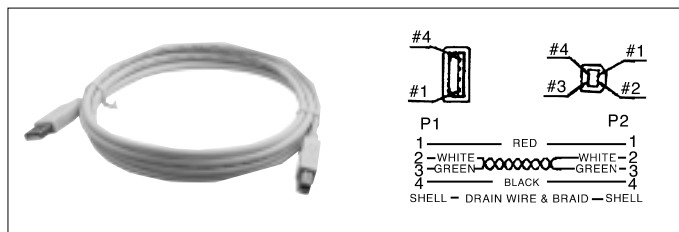

Cavo con spina USB/A e spina USB/B - Lunghezza 1,80 m - Colore beige - Ref. 3-072-924
Cavo con spina USB/A e spina USB/B - Lunghezza 4,50 m - Colore beige - Ref. 3-072-925

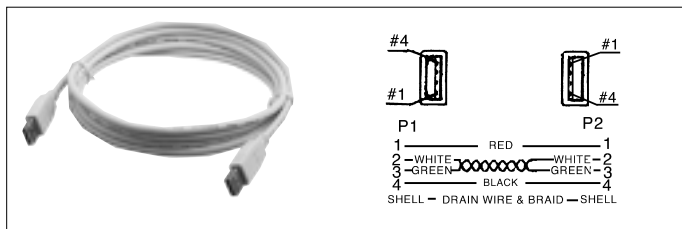

Cavo con doppia spina USB/A - Colore beige
Lunghezza 1,80 m Ref. 3-072-922
Lunghezza 4,5 m Ref. 3-072-923



Cavo da spina USB/A a presa USB/A
Colore beige
Lungh. 1.80 m Ref. 3072927
Lungh. 4.50 m Ref. 3072929

ADATTATORI E TERMINALI SCSI

174



Adattatori SCSI-I a SCSI-II
H.P. CEN 50 femmina a CEN 50 maschio Ref. 3-072-230
H.P. D-SUB 50 femmina a CEN 50 maschio Ref. 3-072-231
H.P. CEN 50 femmina a CEN 50 femmina Ref. 3-072-232
H.P. D-SUB 50 femmina a CEN 50 femmina Ref. 3-072-233



Terminatore SCSI-II H.P. D-SUB 50 maschio
- Attivo Ref. 3-072-259
- Passivo Ref. 3-072-270



Terminatore SCSI-I CEN 50 maschio
- Attivo Ref. 3-072-271
- Passivo Ref. 3-072-281

ADATTATORI USB



Adattatore doppio maschio USB/A
Ref. 3-072-910

Adattatore doppio femmina USB/A
Ref. 3-072-912

Adattatore doppio da maschio USB/A a femmina USB/B
Ref. 3-072-914

Adattatore doppio maschio USB/B
Ref. 3-072-916



Adattatore doppio da femmina USB/A a maschio USB/B
Ref. 3-072-920

Adattatore doppio da femmina USB/B a femmina USB/A
Ref. 3-072-918

Adattatore doppia femmina USB/B
Ref. 3-072-921

CONNETTORI USB E IEE 1394 - Confezione minima 10 pz. per tipo

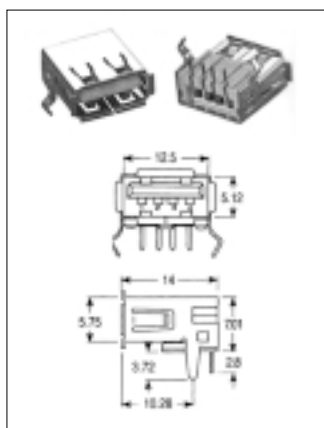

Connettori USB
 Custodia: PBT poliestere alta temperatura e fiberglass UL 94V-0
 Contatti: bronzo fosforoso
 Resistenza di contatto: 30 mΩ max
 Resistenza d'isolamento: 100 mΩ min.
 Forza dielettrica: 500 VDC min.
 Temperatura operativa: -55°C a +105°C
 Corrente di funzionamento: 1A, 30V AC.
 Presa USB/A da c.s. a 90°
 Ref. 3-072-900



Doppia presa USB/A da c.s. 90°
 Ref. 3072902
 Doppia presa USB/A da c.s. 90° con guscio
 Ref. 3072904

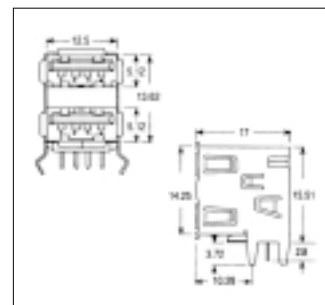

Presse USB/B da c.s. 90°
 Ref. 3072906
 Presse USB/B da c.s. 90° con guscio
 Ref. 3072908

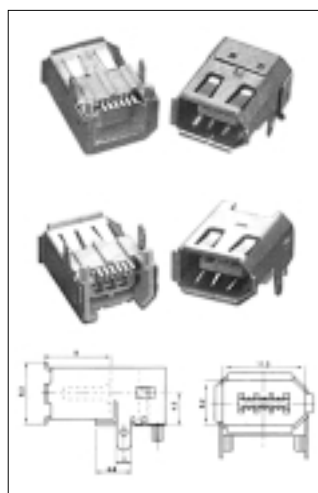
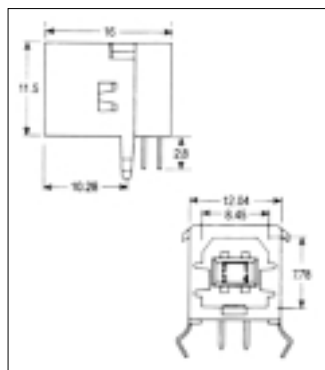

Connettori IEEE 1394
 Custodia: PBT poliestere alta temperatura e fiberglass UL 94V-0
 Contatti: bronzo fosforoso dorati in superficie.
 Durata: 1500 cicli.
 Resistenza di contatto: 30 mΩ max
 Resistenza d'isolamento: 1000 mΩ min.
 Forza dielettrica: 500 VDC min.
 Presa IEEE 1394 da c.s. a 90° Ref. 3-072-930
 Presa IEEE 1394 da c.s. a 90° Ref. 3-072-932

COMMUTATORI SERIALI PER PC

Box in metallo e base in gomma antiscivolo, a due posizioni.



Con entrata USB/B e due uscite USB2/A
 Ref. 3-072-950



Con entrata USB/A e quattro uscite USB4/B
 Ref. 3-072-956



Con entrata USB/A e due uscite USB2/B
 Ref. 3-072-952



VGA - Keyboard - mouse switch boxes - HD15, DB9 e 5 poli DIN
 AB switch box - 2 vie Ref. 3-072-348
 ABCD switch box - 4 vie Ref. 3-072-349

ACCESSORI PER COMPUTER - COMMUTATORI



Con entrata USB/B e quattro uscite USB2/A
Ref. 3-072-954



Apple data switch boxes minidin 8 pin
AB switch box - 2 vie Ref. 3-072-358
ABCD switch box - 4 vie Ref. 3-072-359



Commutatore seriale 2 vie
A-B connettore femmina - D 25 poli
Ref. 3-072-300



Commutatore seriale 4 vie
A-B-C-D connettori centronics femmina 36 poli
Ref. 3-072-308



Commutatore seriale 2 vie
A-B connettori centronics femmina 36 poli
Ref. 3-072-304



Commutatore seriale 4 vie
A-B-C-D connettori femmina - D 25 poli
Ref. 3-072-302

176

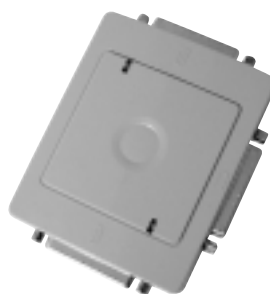

RS-232 Auto data Switch
Automatico a 2 vie 1 entrata - 2 uscite
con 3 prese 25 poli-D
Parallelo Ref. 3-072-272
Seriale Ref. 3-072-273

**Per i vostri ordinativi telefonateci allo 02 95029250,
mandateci un fax allo 02 95029319
oppure scriveteci un e-mail a marcucci@marcucci.it**