

Terminazione femmina N
Corpo in ottone nichelato.
50Ω Ref. 2-080-230
75Ω Ref. 2-080-231

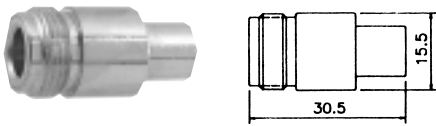

Cappuccio protettivo per connettore femmina N
Corpo in ottone nichelato
Ref. 2-080-235



Cappuccio protettivo per connettore maschio N
Ref. 2-080-240



CONNETTORI TNC - Confezione minima: 10 pz.

Connettore maschio TNC
Corpo in ottone nichelato. Isolamento in derlin
per RG-58U Ref. 2-081-005
per RG-59U Ref. 2-081-006

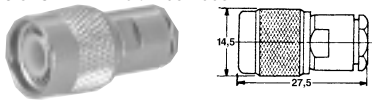

Connettore maschio TNC, a crimpare
Corpo in ottone nichelato. Isolamento in derlin
per RG-58U Ref. 2-081-010
per RG-59U Ref. 2-081-011

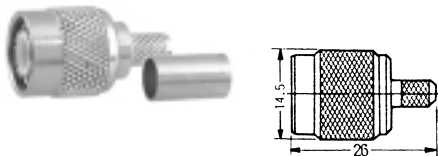

Connettore maschio TNC, da pannello
Fissaggio con dado.
Corpo in ottone nichelato. Isolamento in derlin
Ref. 2-081-013

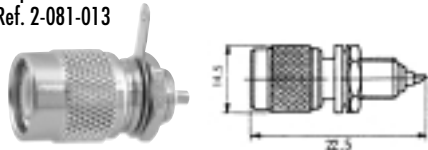

Connettore maschio TNC, a vite
Corpo in ottone nichelato. Isolamento in derlin
per RG-58U Ref. 2-081-015
per RG-59U Ref. 2-081-016

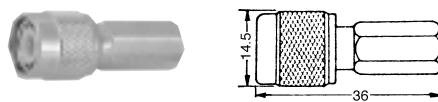

Connettore maschio TNC, a crimpare
Corpo in ottone nichelato. Isolamento in derlin
per RG-58U Ref. 2-081-105
per RG-59U Ref. 2-081-106

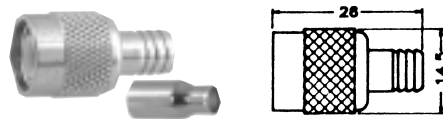

Connettore maschio TNC, a 90°
Fissaggio cavo a morsetto
Corpo in ottone nichelato. Isolamento in derlin
per RG-58U Ref. 2-081-115
per RG-59U Ref. 2-081-116



Connettore maschio TNC, a 90° a crimpare
Corpo in ottone nichelato. Isolamento in derlin
per RG-58U Ref. 2-081-120
per RG-59U Ref. 2-081-121

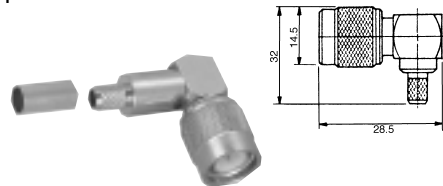

Connettore maschio TNC, a 90°, a vite
per RG-58U Ref. 2-081-125

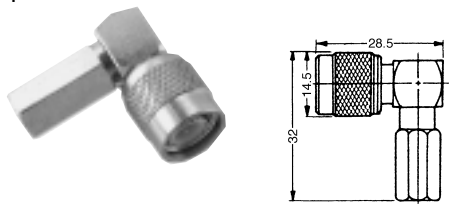

Connettore maschio TNC, bloccaggio cavo a morsetto
Corpo in ottone nichelato. Isolamento in derlin
per RG58U Ref. 2-081-178
per RG59 Ref. 2-081-179

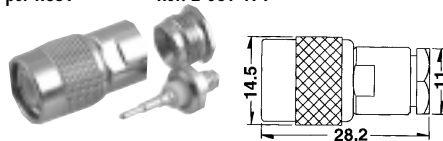

Connettore maschio TNC, a crimpare, innesto veloce
Corpo in ottone nichelato. Isolamento in derlin
per RG-58U Ref. 2-081-195
per RG-59U Ref. 2-081-196

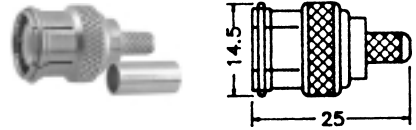

Connettore maschio TNC, a crimpare
Corpo in ottone nichelato. Isolamento in derlin
per RG-58U Ref. 2-081-200
per RG-59U Ref. 2-081-201

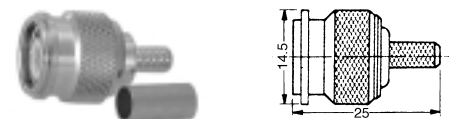

Connettore maschio TNC, a 90°, a crimpare
Corpo in ottone nichelato. Isolamento in derlin
per RG-58U Ref. 2-081-225
per RG-59U Ref. 2-081-226



Connettore maschio TNC, a crimpare
Corpo in ottone nichelato. Isolamento in derlin
per RG-58U Ref. 2-081-235
per RG-59U Ref. 2-081-236

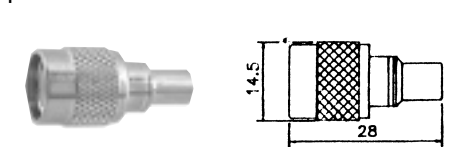

Connettore maschio TNC, a 90°, a crimpare
Corpo in ottone nichelato. Isolamento in derlin
per RG-58U Ref. 2-081-205
per RG-59U Ref. 2-081-206

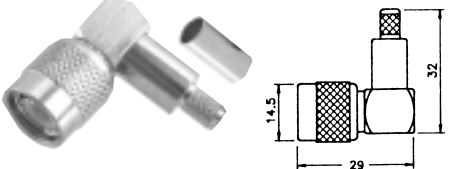

Connettore femmina TNC, a vite
Corpo in ottone nichelato. Isolamento in derlin
per RG-58U Ref. 2-081-020
per RG-59U Ref. 2-081-021

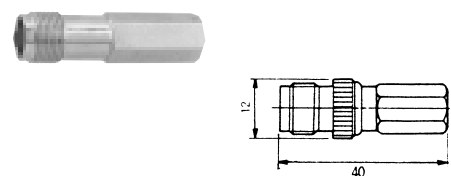

CONNETTORE TNC - Confezione minima: 10 pz.

Connettore femmina TNC, da pannello
Corpo in ottone nichelato. Isolamento in derlin
Ref. 2-081-025

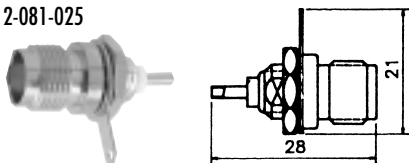

Connettore femmina TNC, da pannello, a crimpare
Corpo in ottone nichelato. Isolamento in derlin
per RG-58U Ref. 2-081-030
per RG-59U Ref. 2-081-031

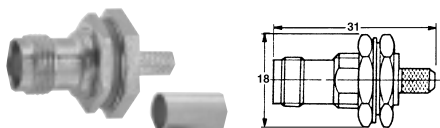

Connettore femmina TNC volante, a crimpare
Corpo in ottone nichelato. Isolamento in derlin
per RG-58U Ref. 2-081-035
per RG-59U Ref. 2-081-036

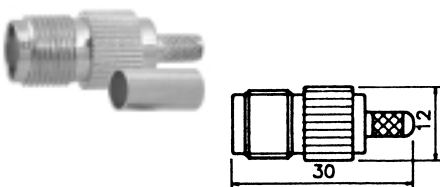

Connettore femmina TNC volante
Corpo in ottone nichelato. Isolamento in derlin
per RG-58U Ref. 2-081-080
per RG-59U Ref. 2-081-081

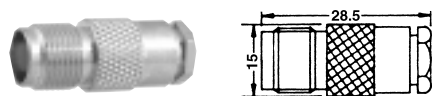

Connettore femmina TNC, da pannello
Corpo in ottone nichelato. Isolamento in derlin
Ref. 2-081-085

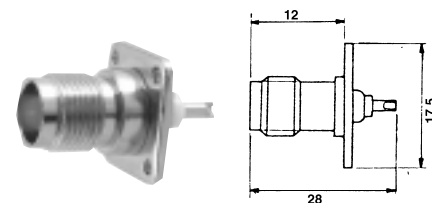

ADATTATORI TNC - Confezione minima: 10 pz.

Adattatore da maschio TNC a femmina BNC
Corpo in ottone nichelato. Isolamento in derlin
Ref. 2-081-040

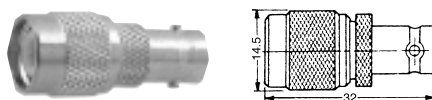

Adattatore da maschio TNC a maschio BNC
Corpo in ottone nichelato. Isolamento in derlin
Ref. 2-081-042

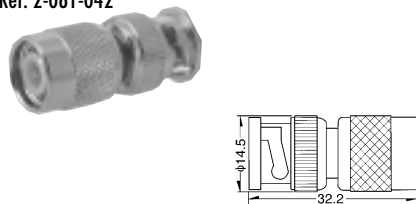

Adattatore da maschio TNC a femmina UHF
Corpo in ottone nichelato. Isolamento in derlin
Ref. 2-081-045

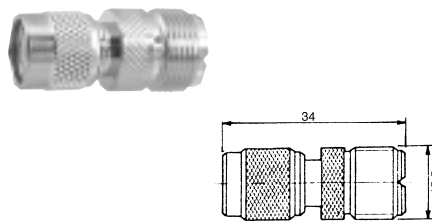

Adattatore da femmina TNC a maschio TNC, innesto veloce
Corpo in ottone nichelato. Isolamento in derlin
Ref. 2-081-046

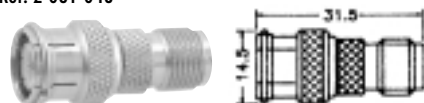

Adattatore da maschio TNC a maschio F
Corpo in ottone nichelato. Isolamento in derlin
Ref. 2-081-048

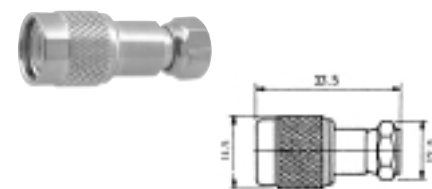

Adattatore a 90° da maschio TNC a femmina TNC
Corpo in ottone nichelato. Isolamento in derlin
Ref. 2-081-050

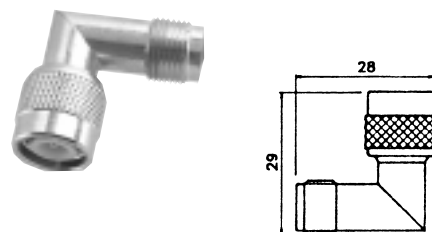

Adattatore doppia femmina TNC
Corpo in ottone nichelato. Isolamento in derlin
Ref. 2-081-055

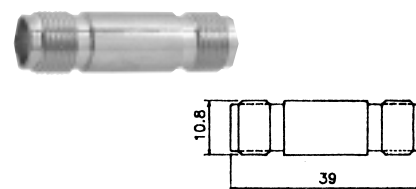

Adattatore doppia femmina TNC
Corpo in ottone nichelato. Isolamento in derlin
Ref. 2-081-060

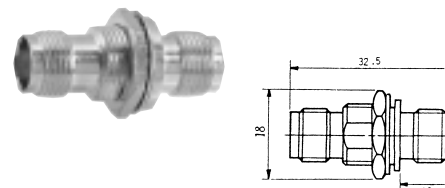

Adattatore da femmina TNC a maschio BNC
Corpo in ottone nichelato. Isolamento in derlin
Ref. 2-081-065

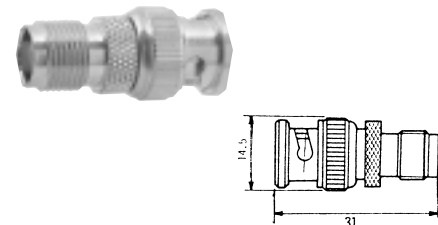

Adattatore a T da maschio TNC a doppia femmina TNC
Corpo in ottone nichelato. Isolamento in derlin
Ref. 2-081-070

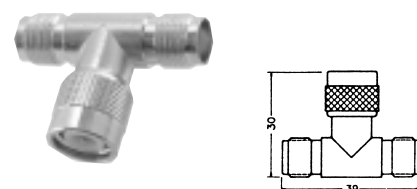

Adattatore a T, tripla femmina TNC
Corpo in ottone nichelato. Isolamento in derlin
Ref. 2-081-075

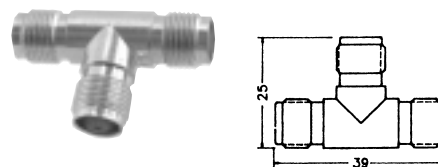

Adattatore a maschio TNC a femmina N
Corpo in ottone nichelato. Isolamento in derlin
Ref. 2-081-090

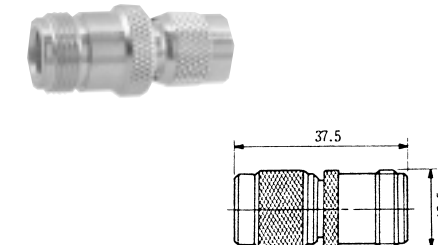

Adattatore doppio maschio TNC

Corpo in ottone nichelato. Isolamento in derlin
Ref. 2-081-095

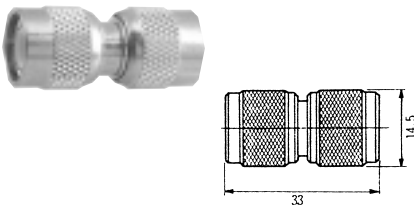

Spina TNC "cable pin"

Corpo in ottone nichelato. Isolamento in derlin
Ref. 2-081-100

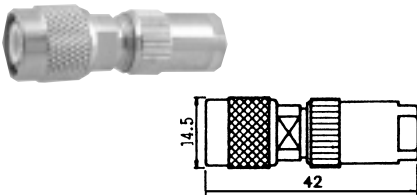

Connettore femmina TNC, a 90°, da pannello

Corpo in ottone nichelato. Isolamento in derlin
Ref. 2-081-130

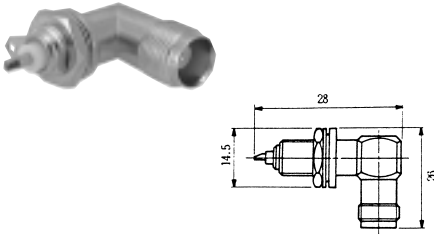

Adattatore da maschio TNC a maschio UHF

Corpo in ottone nichelato. Isolamento in derlin
Ref. 2-081-135

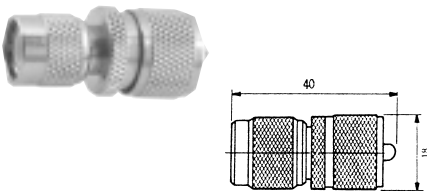

Adattatore da maschio TNC a femmina F

Corpo in ottone nichelato. Isolamento in derlin
Ref. 2-081-140

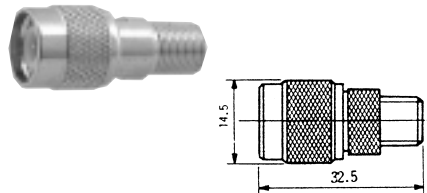

Adattatore da maschio TNC a maschio RCA

Corpo in ottone nichelato. Isolamento in derlin
Ref. 2-081-145

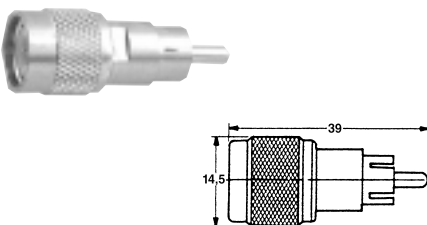

Adattatore da maschio TNC a femmina RCA

Corpo in ottone nichelato. Isolamento in derlin
Ref. 2-081-150

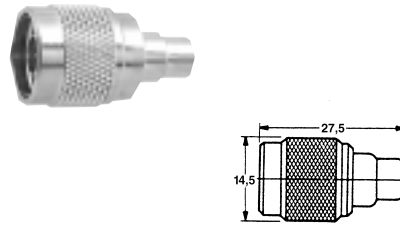

Adattatore da maschio TNC a femmina TNC

Corpo in ottone nichelato. Isolamento in derlin
Ref. 2-081-155

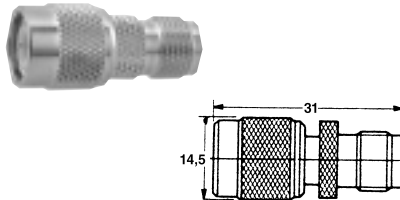

Adattatore da femmina TNC a femmina UHF

Corpo in ottone nichelato. Isolamento in derlin
Ref. 2-081-160

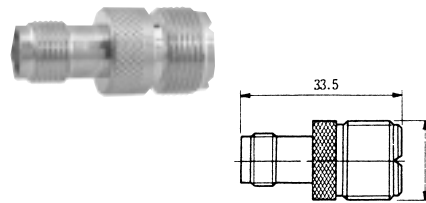

Adattatore da femmina TNC a femmina F

Corpo in ottone nichelato. Isolamento in derlin
Ref. 2-081-165

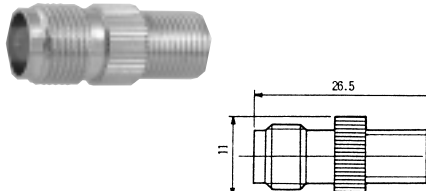

Adattatore da femmina TNC a maschio RCA

Corpo in ottone nichelato. Isolamento in derlin
Ref. 2-081-170

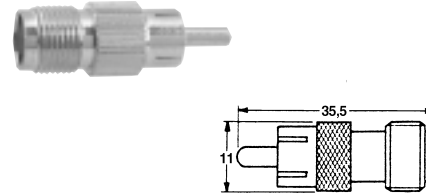

Adattatore doppia femmina TNC, da pannello

Fissaggio con dado
Corpo in ottone nichelato. Isolamento in derlin
Ref. 2-081-177

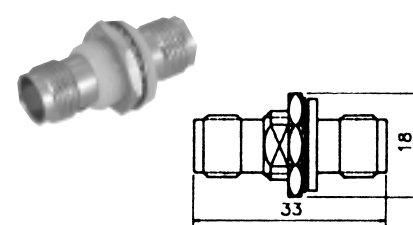

Adattatore a T da maschio TNC a doppia femmina TNC

Corpo in ottone nichelato. Isolamento in derlin
Ref. 2-081-190

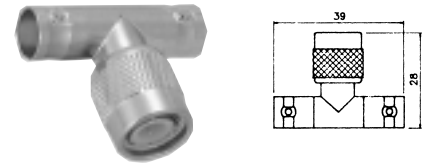

Adattatore da femmina TNC a maschio NEC

Corpo in ottone nichelato. Isolamento in derlin
Ref. 2-081-230

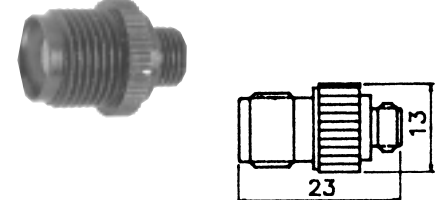

Terminazione maschio TNC

Corpo in ottone nichelato. Isolamento in derlin
50Ω Ref. 2-081-240
75Ω Ref. 2-081-241

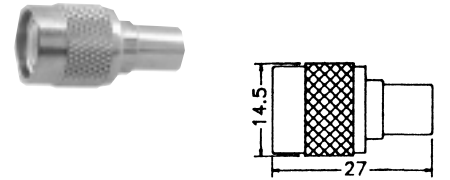

Cappuccio protettivo per connettore femmina TNC

Corpo in ottone nichelato.
Ref. 2-081-210

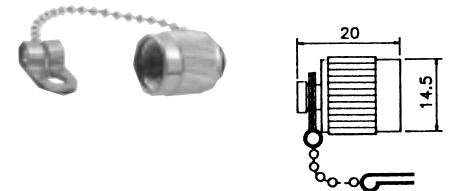

Cappuccio protettivo per connettore maschio TNC

Corpo in ottone nichelato.
Ref. 2-081-215

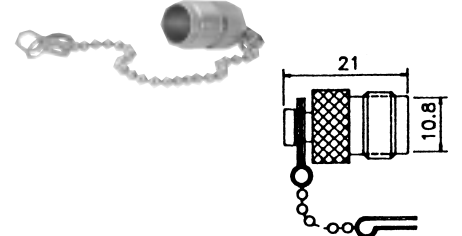

CONNETTORI PER ANTENNA

CONNETTORI PER ANTENNA - Conf. minima: 10 pz.

Connettore maschio FME filettato a crimpare
Corpo in ottone nichelato. Isolamento in derlin
Ref. 2-082-015

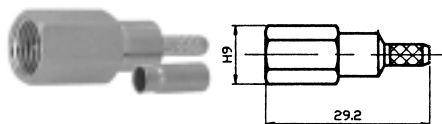

Connettore maschio BNC per antenna
Corpo in ottone nichelato. Isolamento in derlin
Ref. 2-082-125

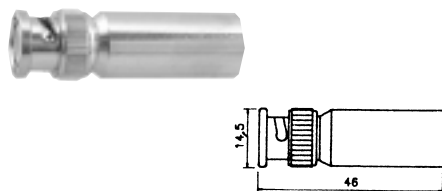

Connettore maschio FME, a crimpare
Corpo in ottone nichelato. Isolamento in derlin
per RG58U Ref. 2-082-150
per RG174U Ref. 2-082-155

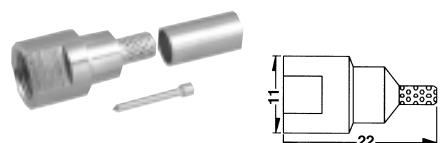

Connettore femmina FME filettata, a crimpare
Corpo in ottone nichelato. Isolamento in derlin
Ref. 2-082-005

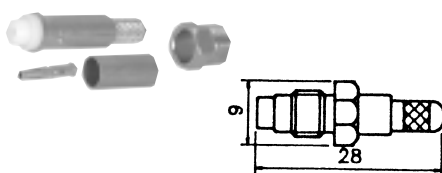

Connettore femmina FME filettata, a crimpare
Corpo in ottone nichelato. Isolamento in derlin
per RG58U Ref. 2-082-010

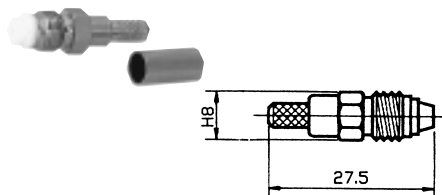

Connettore femmina UHF, a 90° per antenna, per RG-58U
Corpo in ottone nichelato. Isolamento in derlin
Ref. 2-082-140



ADATTATORI PER ANTENNA - Conf. minima: 10 pz.

Adattatore doppio maschio FME
Corpo in ottone nichelato. Isolamento in derlin
Ref. 2-082-020

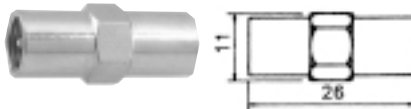

Adattatore da maschio FME filettato a maschio N
Corpo in ottone nichelato. Isolamento in derlin
Ref. 2-082-025

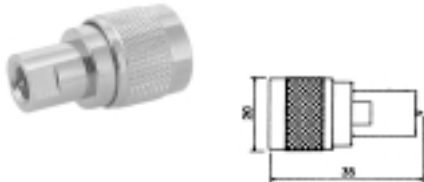

Adattatore da maschio FME filettato a maschio mini UHF
Corpo in ottone nichelato. Isolamento in derlin
Ref. 2-082-030

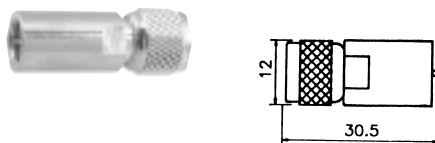

Adattatore da maschio FME filettato a maschio BNC
Corpo in ottone nichelato. Isolamento in derlin
Ref. 2-082-035

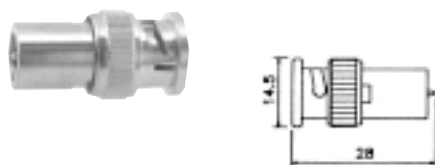

Adattatore 90° da maschio FME filettato a maschio BNC
Ref. 2-082-040

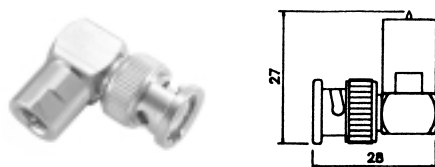

Adattatore da maschio FME filettato a maschio TNC
Corpo in ottone nichelato. Isolamento in derlin
Ref. 2-082-045

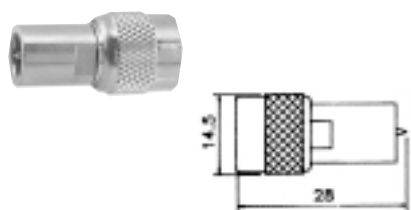

Adattatore 90° da maschio FME filettato a maschio TNC
Corpo in ottone nichelato. Isolamento in derlin
Ref. 2-082-050

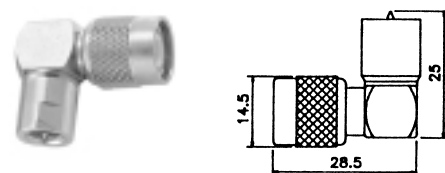

Adattatore da maschio FME filettato a maschio UHF
Corpo in ottone nichelato. Isolamento in derlin
Ref. 2-082-055

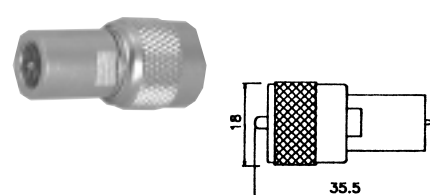

Adattatore da maschio FME filettato a maschio SMA
Corpo in ottone nichelato. Isolamento in derlin
Ref. 2-082-060

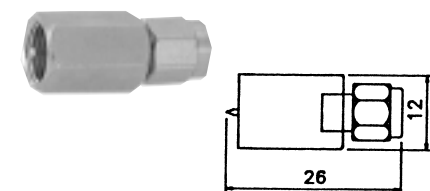

Adattatore da maschio FME filettato a femmina TNC
Ref. 2-082-065

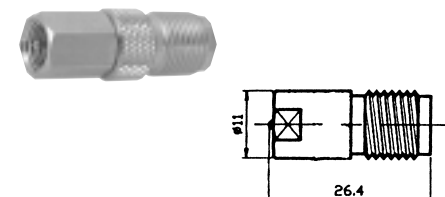

Adattatore da femmina FME filettato a femmina TNC
Corpo in ottone nichelato. Isolamento in derlin
Ref. 2-082-070

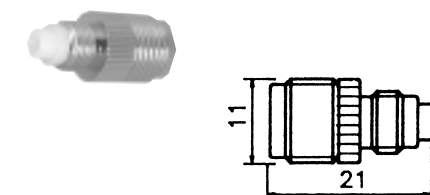

Adattatore da femmina FME filettato a maschio TNC
Corpo in ottone nichelato. Isolamento in derlin
Ref. 2-082-075

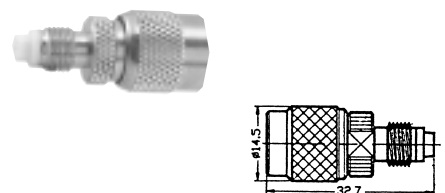

Adattatore da maschio FME filettato a femmina mini UHF
Corpo in ottone nichelato. Isolamento in derlin
Ref. 2-082-080

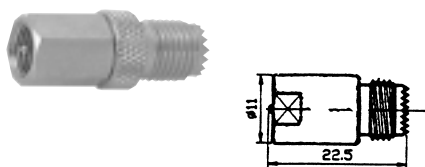

Adattatore da femmina FME filettato a femmina mini UHF
Corpo in ottone nichelato. Isolamento in derlin
Ref. 2-082-085

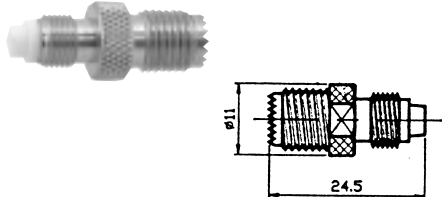

Adattatore da femmina FME filettato a femmina mini UHF
Corpo in ottone nichelato. Isolamento in derlin
Ref. 2-082-090

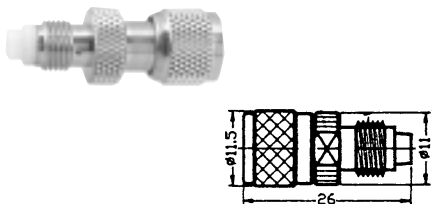

Adattatore da maschio FME filettato a femmina BNC
Corpo in ottone nichelato. Isolamento in derlin
Ref. 2-082-095

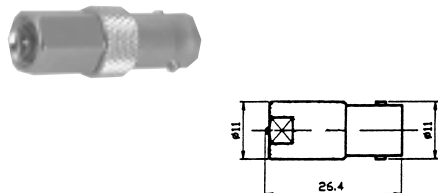

Adattatore da femmina FME filettato a maschio BNC
Corpo in ottone nichelato. Isolamento in derlin
Ref. 2-082-100

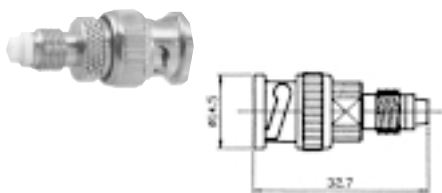

Adattatore da femmina FME filettato a femmina BNC
Corpo in ottone nichelato. Isolamento in derlin
Ref. 2-082-105

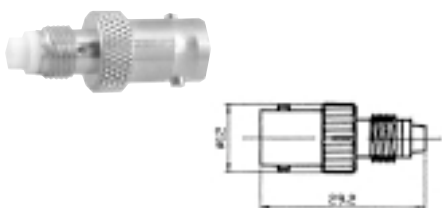

Adattatore da maschio FME filettato a femmina SMA
Corpo in ottone nichelato. Isolamento in derlin
Ref. 2-082-110

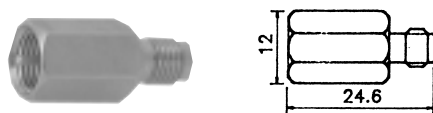

Adattatore da femmina FME filettato a femmina SMA
Corpo in ottone nichelato. Isolamento in derlin
Ref. 2-082-115



Adattatore da maschio FME filettato a maschio SMA
Corpo in ottone nichelato. Isolamento in derlin
Ref. 2-082-120



Adattatore doppia femmina FME
Corpo in ottone nichelato. Isolamento in derlin
Ref. 2-082-145

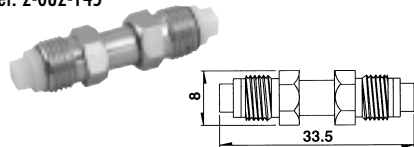

CONNETTORI TWINAX - Confezione minima: 10 pz.

Connettore maschio Twin
Corpo in ottone nichelato. Isolamento in derlin
Ref. 2-083-005

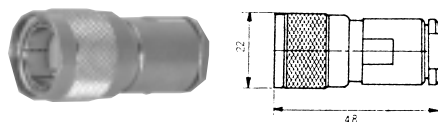

Connettore femmina Twin, presa da pannello
Corpo in ottone nichelato. Isolamento in derlin
Ref. 2-083-015

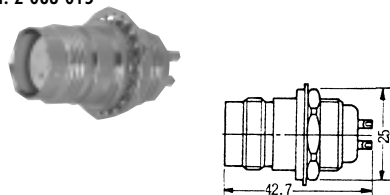

Connettore femmina Twin, volante,
per RG-8227
Corpo in ottone nichelato. Isolamento in derlin
Ref. 2-083-020

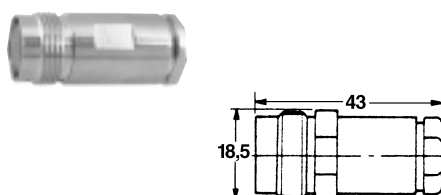

Connettore femmina Twin, da pannello
Corpo in ottone nichelato. Isolamento in derlin
Ref. 2-083-050

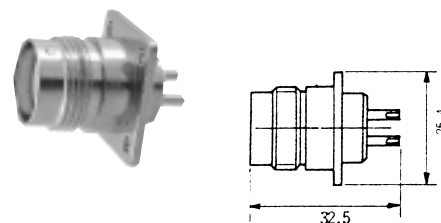

Connettore maschio Twin, a crimpare
Corpo in ottone nichelato. Isolamento in derlin
Ref. 2-083-040

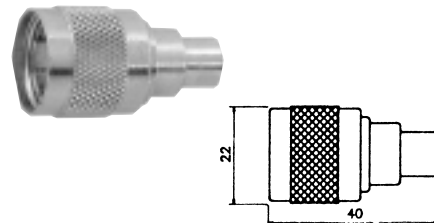

Adattatore doppia femmina Twin
Corpo in ottone nichelato. Isolamento in derlin
Ref. 2-083-010

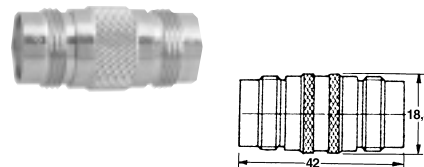

Adattatore tripla femmina Twin
Corpo in ottone nichelato. Isolamento in derlin
Ref. 2-083-025

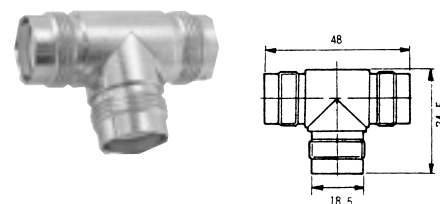

Adattatore a 90° da maschio Twin a femmina Twin
Corpo in ottone nichelato. Isolamento in derlin
Ref. 2-083-052

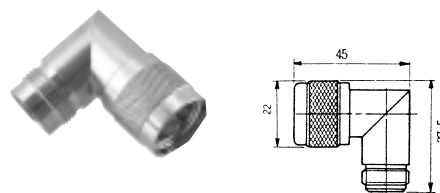

Adattatore doppia femmina Twin, da pannello
Corpo in ottone nichelato. Isolamento in derlin
Ref. 2-083-030

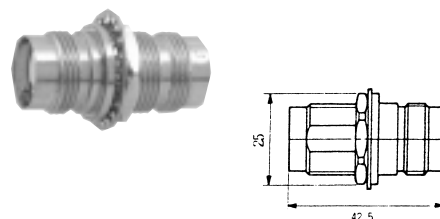

CONNETTORI TWINAX - Confezione minima: 10 pz.

Adattatore da maschio Twin a doppia femmina Twin
Corpo in ottone nichelato. Isolamento in derlin
Ref. 2-083-035

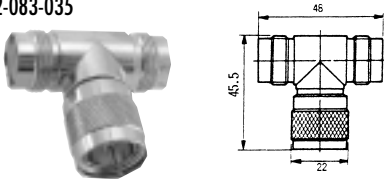

Cappuccio protettivo per connettore femmina Twin
Corpo in ottone nichelato.
Ref. 2-083-055

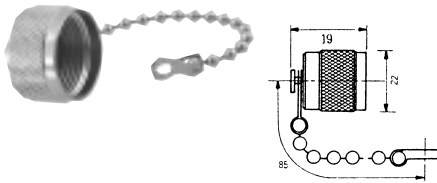

CONNETTORI VARI- Confezione minima: 10 pz.

Connettore maschio RCA
Manicotto isolante in PVC. Contatti in ottone nichelato.
Fissaggio del cavo a vite
Ref. 2-084-005

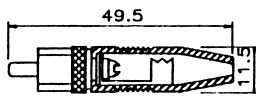

Connettore maschio F
Manicotto isolante in PVC. Contatti in ottone nichelato.
Fissaggio del cavo a vite
Ref. 2-084-010

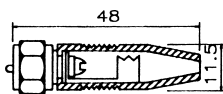

Connettore maschio F
Manicotto isolante in PVC. Contatti in ottone nichelato.
Fissaggio del cavo a vite
Ref. 2-084-015

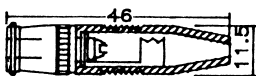

Connettore maschio BNC
Manicotto isolante in PVC. Contatti in ottone nichelato.
Fissaggio del cavo a vite
Ref. 2-084-020

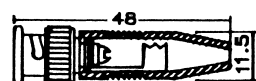

Connettore femmina BNC
Manicotto isolante in PVC. Contatti in ottone nichelato.
Fissaggio del cavo a vite
Ref. 2-084-025

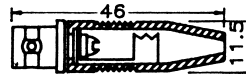

Connettore maschio UHF
Manicotto isolante in PVC. Contatti in ottone nichelato.
Fissaggio del cavo a vite
Ref. 2-084-030

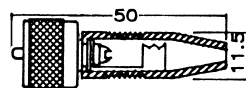

Connettore maschio RCA a 90°
Manicotto isolante in PVC. Contatti in ottone nichelato.
Fissaggio del cavo a vite
Ref. 2-084-035

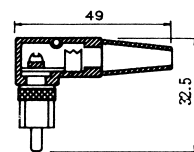

Connettore maschio F, a 90°
Manicotto isolante in PVC. Contatti in ottone nichelato.
Fissaggio del cavo a vite
Ref. 2-084-040

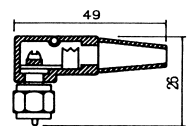

Connettore maschio F, a 90°
Manicotto isolante in PVC. Contatti in ottone nichelato.
Fissaggio del cavo a vite
Ref. 2-084-045

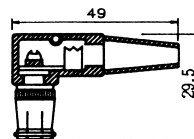

Connettore maschio BNC, a 90°
Manicotto isolante in PVC. Contatti in ottone nichelato.
Fissaggio del cavo a vite
Ref. 2-084-050

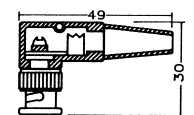

Connettore femmina BNC, a 90°
Manicotto isolante in PVC. Contatti in ottone nichelato.
Fissaggio del cavo a vite
Ref. 2-084-055

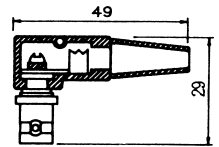

Connettore maschio UHF, a 90°
Manicotto isolante in PVC. Contatti in ottone nichelato.
Fissaggio del cavo a vite
Ref. 2-084-060

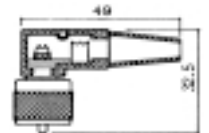

Connettore PAL maschio
Manicotto isolante in PVC. Contatti in ottone nichelato.
Fissaggio del cavo a vite
Ref. 2-084-032

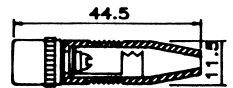

Connettore PAL femmina
Manicotto isolante in PVC. Contatti in ottone nichelato.
Fissaggio del cavo a vite
Ref. 2-084-033

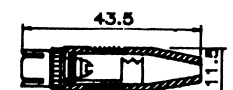

Connettore PAL maschio 90°
Manicotto isolante in PVC. Contatti in ottone nichelato.
Fissaggio del cavo a vite
Ref. 2-084-062

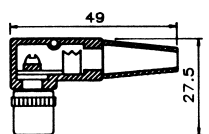

Connettore PAL femmina 90°
Manicotto isolante in PVC. Contatti in ottone nichelato.
Fissaggio del cavo a vite
Ref. 2-084-063

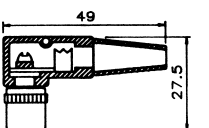

CONNETTORI VARI - Confezione minima: 10 pz.

Connettore TNC maschio 90°
Manicotto isolante in PVC. Contatti in ottone nichelato.
Fissaggio del cavo a vite
Ref. 2-084-068



Connettore TNC maschio
Manicotto isolante in PVC. Contatti in ottone nichelato.
Fissaggio del cavo a vite
Ref. 2-084-065

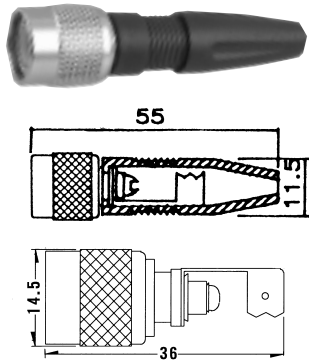

CONNETTORI MICROFONICI Confezione minima: 20 pz.

Connettore maschio volante
Corpo in ottone cromato. Isolamento in plastica ABS
3 poli Ref. 2-023-456
4 poli Ref. 2-023-460
5 poli Ref. 2-023-464



Connettore femmina volante
Corpo in ottone cromato. Isolamento in plastica ABS
3 poli Ref. 2-023-457
4 poli Ref. 2-023-461
5 poli Ref. 2-023-465

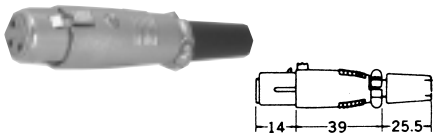

Connettore maschio da pannello
Corpo in ottone cromato. Isolamento in plastica ABS
3 poli Ref. 2-023-458
4 poli Ref. 2-023-463
5 poli Ref. 2-023-467

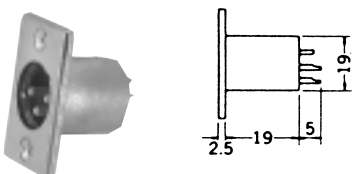

Connettore femmina da pannello
Corpo in ottone cromato. Isolamento in plastica ABS
3 poli Ref. 2-023-459
4 poli Ref. 2-023-462
5 poli Ref. 2-023-466

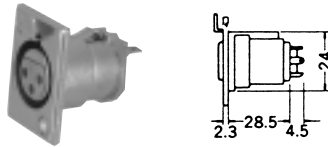

Connettore femmina da pannello
Corpo in ottone cromato. Isolamento in plastica ABS
3 poli Ref. 2-023-403
4 poli Ref. 2-023-404
5 poli Ref. 2-023-405

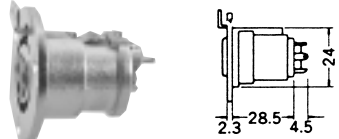

ADATTATORI MICROFONICI - Conf. minima: 10 pz.

Adattatore microfonico 3 poli maschio-maschio
Corpo in ottone cromato. Isolamento in plastica ABS
Ref. 2-023-420



Adattatore microfonico 3 poli femmina-femmina
Corpo in ottone cromato. Isolamento in plastica ABS
Ref. 2-023-422



Adattatore microfonico 3 poli femmina-spina jack
3 cont. - 6,3mm
Corpo in ottone cromato. Isolamento in plastica ABS
Ref. 2-023-424



Adattatore microfonico 3 poli maschio-spina jack
3 cont. - 6,3mm
Corpo in ottone cromato. Isolamento in plastica ABS
Ref. 2-023-426



CONNETTORI MICROFONICI SCHERMATI PER BASSA FREQUENZA - Confezione minima: 10 pz.

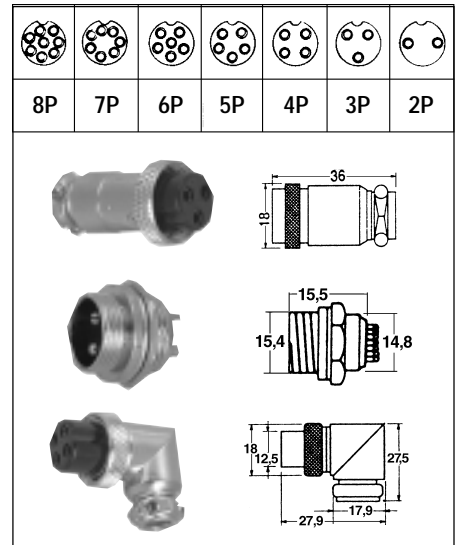

Connettore femmina BF - 2 poli
Tipo a 90°
Ref. 2-085-005
Ref. 2-085-015



Connettore femmina BF - 3 poli
Tipo a 90°
Ref. 2-085-006
Ref. 2-085-016



Connettore femmina BF - 4 poli
Tipo a 90°
Ref. 2-085-007
Ref. 2-085-017



Connettore femmina BF - 5 poli
Tipo a 90°
Ref. 2-085-008
Ref. 2-085-018



CONNETTORI MICROFONICI

CONNETTORI MICROFONICI SCHERMATI PER BASSA FREQUENZA - Confezione minima: 10 pz.

Corpo in ottone cromato - Isolamento in resina fenolica
 Connettore femmina BF - 6 poli Ref. 2-085-009
 Tipo a 90° Ref. 2-085-019



Connettore femmina BF - 7 poli Ref. 2-085-010
 Tipo a 90° Ref. 2-085-020



Connettore femmina BF - 8 poli Ref. 2-085-011
 Tipo a 90° Ref. 2-085-021



Connettore maschio BF - 2 poli da pannello, con fissaggio a vite Ref. 2-085-025



Connettore maschio BF - 3 poli da pannello, con fissaggio a vite Ref. 2-085-026



Connettore maschio BF - 4 poli da pannello, con fissaggio a vite Ref. 2-085-027



Connettore maschio BF - 5 poli da pannello, con fissaggio a vite Ref. 2-085-028



Connettore maschio BF - 6 poli da pannello, con fissaggio a vite Ref. 2-085-029



Connettore maschio BF - 7 poli da pannello, con fissaggio a vite Ref. 2-085-030



Connettore maschio BF - 8 poli da pannello, con fissaggio a vite Ref. 2-085-031



SPINE MICROFONICHE SCHERMATI PER BASSA FREQUENZA - Confe. minima: 10 pz.

Corpo in ottone cromato. Isolamento in resina fenolica

2 poli Ref. 2-085-040 6 poli Ref. 2-023-044
 3 poli Ref. 2-085-041 7 poli Ref. 2-023-045
 4 poli Ref. 2-085-042 8 poli Ref. 2-023-046
 5 poli Ref. 2-023-043



8P	7P	6P	5P	4P	3P	2P

KIT CONNETTORI E ADATTATORI UNIVERSALI DORATI E CROMATI



Kit connettori/adattatori dorati universali in elegante astuccio in similpelle con chiusura a cerniera.

KIT n. 1 (totale: 30 pezzi dorati)
 2 pezzi maschio e femmina tipo UHF, mini UHF, N, BNC, TNC, SMA + 6 pezzi di adattatori universali
 Ref. 2-023-492
 Come sopra ma cromati
 Ref. 2-023-490

KIT n. 2 (totale: 40 pezzi dorati)
 2 pezzi maschio e femmina tipo UHF, mini UHF, N, BNC, TNC, SMA, RCA, F + 8 pezzi adattatori universali
 Ref. 2-023-497